

NG40 - S2-C

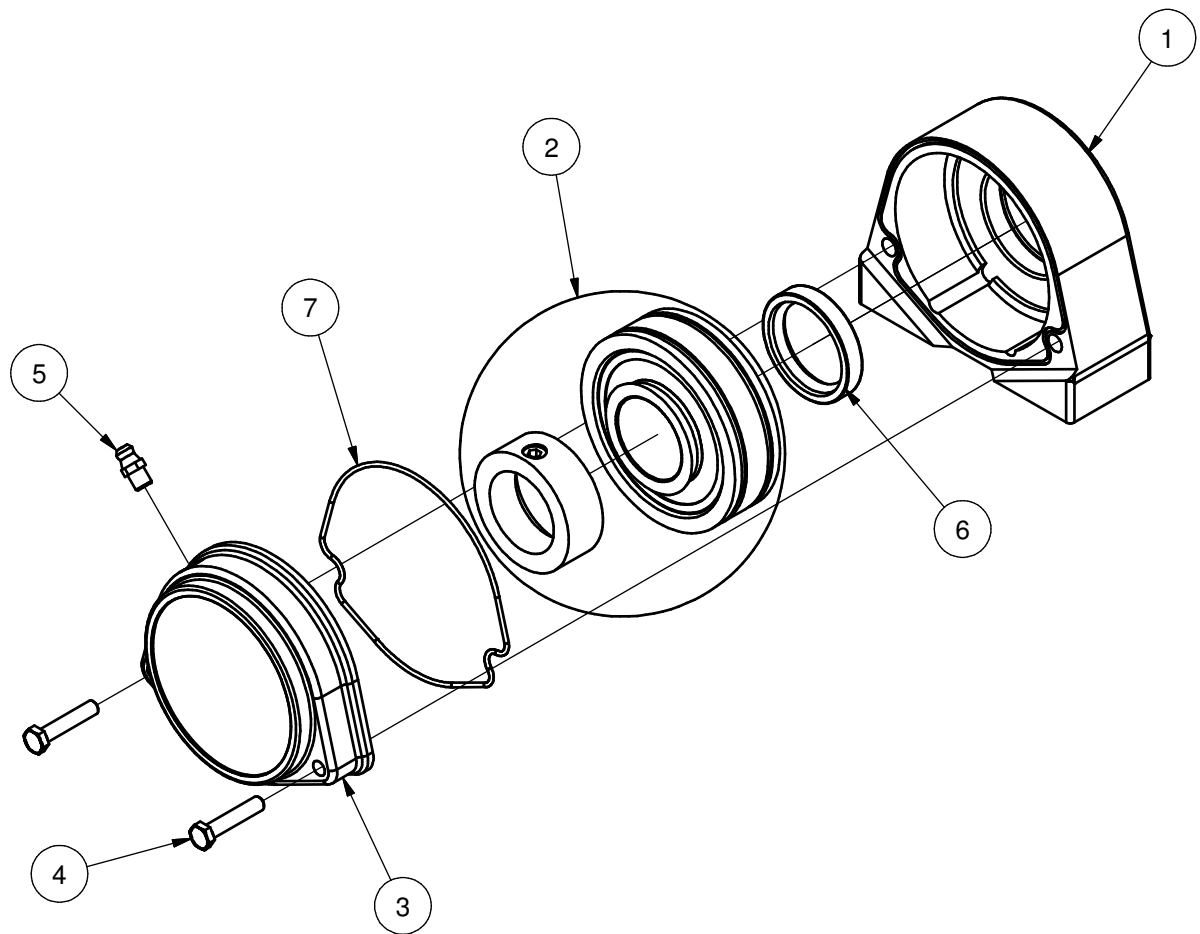

A-A

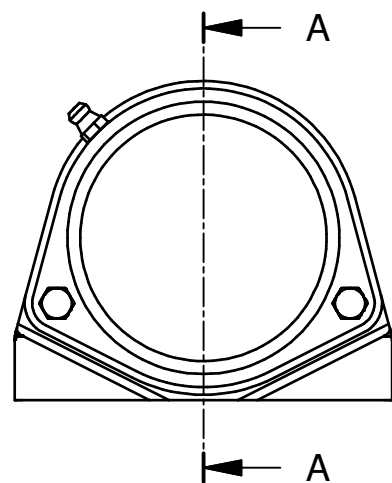
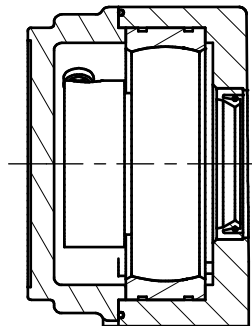

Pos	Pcs	Identifications no.	Description
1	1	NG40 - S2 - 1	Housing Unit
2	1	NG40 - S2 - 2	Ball Bearing
3	1	NG40 - S2 - C-3	Cover (Closed)
4	2	NG40 - S2 - 4	Set Bolt
5	1	NG40 - S2 - 5	Lubrication Nipple
6	1	NG40 - S2 - 6	Shaft Seal Ring
7	1	NG40 - S2 - 7	O-Ring

BJ-Gear A/S

Niels Bohrs Vej 47	Phone	+45 87 40 80 80
DK-8660 Skanderborg	Fax	+45 87 40 80 81
Denmark	Email	bj@bj-gear.com
VAT No. DK 10166470	Website	www.bj-gear.com

This drawing is a property of BJ-Gear A/S and may not be copied or used without permission