

NG35 - SF2-O

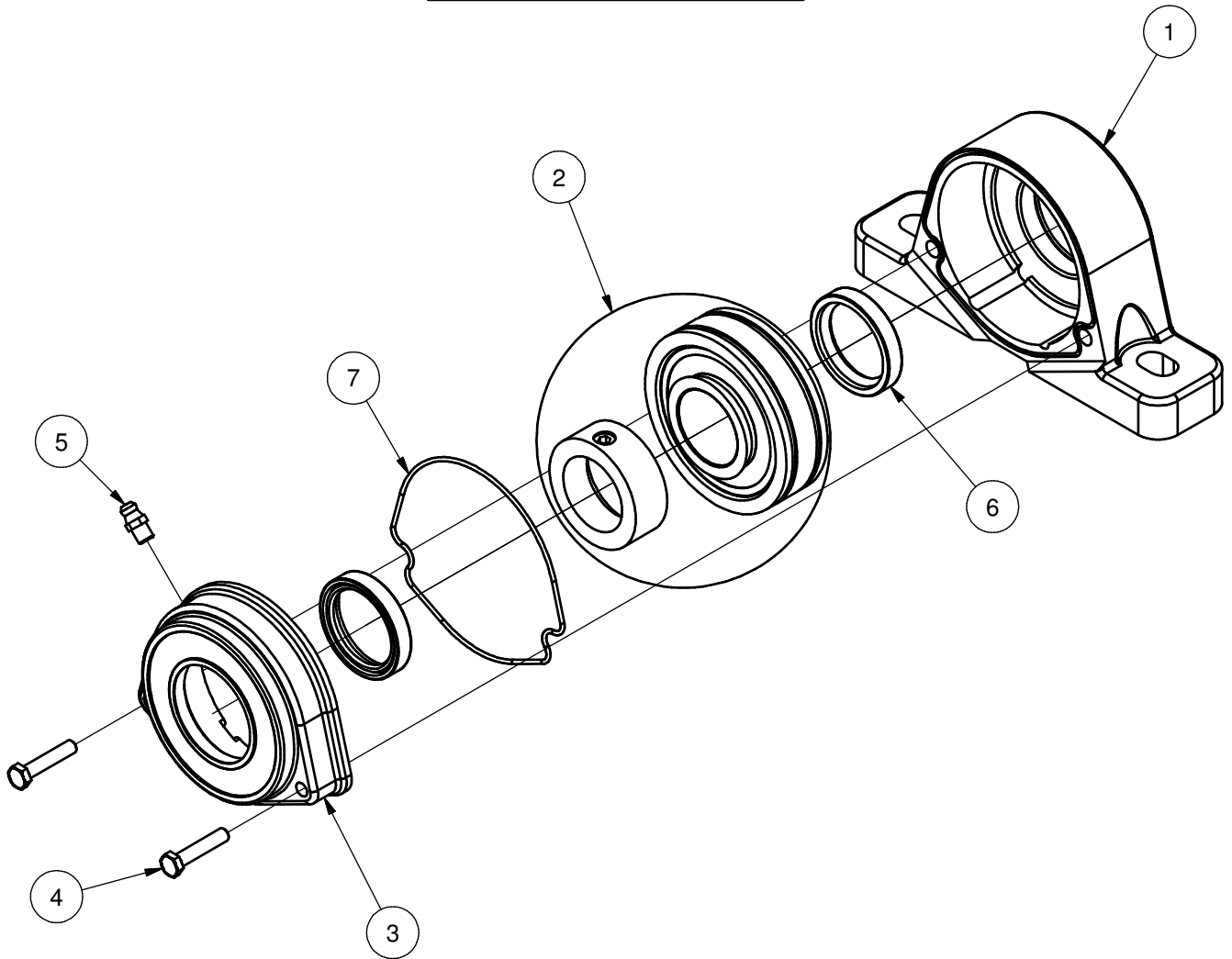

A-A

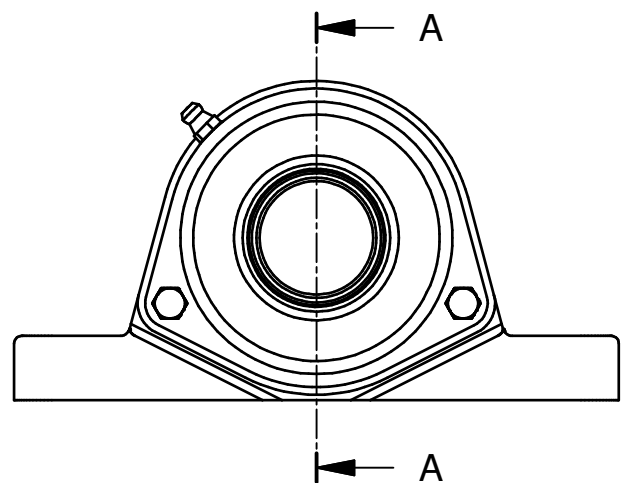
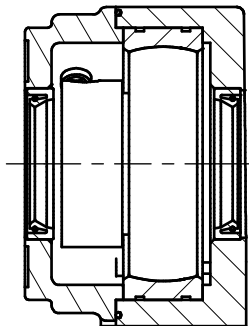

Pos	Pcs	Identifications no.	Description
1	1	NG35 - SF2 - 1	Housing Unit
2	1	NG35 - SF2 - 2	Ball Bearing
3	1	NG35 - SF2 - O-3	Cover (Open)
4	2	NG35 - SF2 - 4	Set Bolt
5	1	NG35 - SF2 - 5	Lubrication Nippel
6	2	NG35 - SF2 - 6	Shaft Seal Ring
7	1	NG35 - SF2 - 7	O-Ring

BJ-Gear A/S

Niels Bohrs Vej 47 Phone +45 87 40 80 80
 DK-8660 Skanderborg Fax +45 87 40 80 81
 Denmark Email bj@bj-gear.com
 VAT No. DK 10166470 Website www.bj-gear.com

This drawing is a property of BJ-Gear A/S and may not be copied or used without permission